

# Pyxis<sup>®</sup>

## EM-500 Inline Algae Sensor User Manual



Water Professionals Deserve Better Tools.

[www.pyxis-lab.com](http://www.pyxis-lab.com)

# EM-500 Inline Chlorophyll-a Fluorometer User Manual

January 22, 2021  
Rev. 3.01

**Pyxis Lab, Inc.**  
1729 Majestic Dr. Suite 5  
Lafayette, CO 80026 USA  
[www.pyxis-lab.com](http://www.pyxis-lab.com)

## Table of Contents

|           |   |           |
|-----------|---|-----------|
| <b>1</b>  | <b>Introduction</b>                                   | <b>2</b>  |
| <b>2</b>  | <b>Specifications</b>                                 | <b>3</b>  |
| <b>3</b>  | <b>Unpacking Instrument</b>                           | <b>3</b>  |
| 3.1       | Standard Accessories . . . . .                        | 3         |
| 3.2       | Optional Accessories . . . . .                        | 4         |
| <b>4</b>  | <b>Installation</b>                                   | <b>5</b>  |
| 4.1       | Pipeline Installation . . . . .                       | 5         |
| 4.2       | Submersed Installation . . . . .                      | 6         |
| 4.3       | Wiring . . . . .                                      | 6         |
| 4.4       | Connecting via Bluetooth . . . . .                    | 7         |
| 4.5       | Connecting via USB . . . . .                          | 7         |
| <b>5</b>  | <b>Setup and Calibration with uPyxis® Mobile App</b>  | <b>8</b>  |
| 5.1       | Download uPyxis® Mobile App . . . . .                 | 8         |
| 5.2       | Connecting to uPyxis® Mobile App . . . . .            | 9         |
| 5.3       | Calibration Screen and Reading . . . . .              | 10        |
| 5.4       | Diagnosis Screen . . . . .                            | 11        |
| 5.5       | Device Info Screen . . . . .                          | 11        |
| <b>6</b>  | <b>Setup and Calibration with uPyxis® Desktop App</b> | <b>12</b> |
| 6.1       | Install uPyxis® Desktop App . . . . .                 | 12        |
| 6.2       | Connecting to uPyxis® Desktop App . . . . .           | 13        |
| 6.3       | Information Screen . . . . .                          | 14        |
| 6.4       | Calibration Screen . . . . .                          | 14        |
| 6.5       | Diagnosis Screen . . . . .                            | 15        |
| <b>7</b>  | <b>Outputs</b>  | <b>15</b> |
| 7.1       | 4–20mA Output Setup . . . . .                         | 15        |
| 7.2       | Adjusting 4–20mA Span . . . . .                       | 16        |
| 7.3       | Communication using Modbus RTU . . . . .              | 16        |
| <b>8</b>  | <b>Sensor Maintenance and Precaution</b>              | <b>17</b> |
| 8.1       | Methods to Cleaning EM-500 Sensor . . . . .           | 17        |
| 8.2       | Storage . . . . .                                     | 18        |
| <b>9</b>  | <b>Troubleshooting</b>                                | <b>18</b> |
| <b>10</b> | <b>Contact Us</b>                                     | <b>18</b> |

## **Warranty Information**

### **Confidentiality**

The information contained in this manual may be confidential and proprietary and is the property of Pyxis Lab, Inc. Information disclosed herein shall not be used to manufacture, construct, or otherwise reproduce the goods described. Information disclosed herein shall not be disclosed to others or made public in any manner without the express written consent of Pyxis Lab, Inc.

### **Standard Limited Warranty**

Pyxis Lab warrants its products for defects in materials and workmanship. Pyxis Lab will, at its option, repair or replace instrument components that prove to be defective with new or remanufactured components (i.e., equivalent to new). The warranty set forth is exclusive and no other warranty, whether written or oral, is expressed or implied.

### **Warranty Term**

The Pyxis warranty term is thirteen (13) months ex-works. In no event shall the standard limited warranty coverage extend beyond thirteen (13) months from original shipment date.

### **Warranty Service**

Damaged or dysfunctional instruments may be returned to Pyxis for repair or replacement. In some instances, replacement instruments may be available for short duration loan or lease.

Pyxis warrants that any labor services provided shall conform to the reasonable standards of technical competency and performance effective at the time of delivery. All service interventions are to be reviewed and authorized as correct and complete at the completion of the service by a customer representative, or designate. Pyxis warrants these services for 30 days after the authorization and will correct any qualifying deficiency in labor provided that the labor service deficiency is exactly related to the originating event. No other remedy, other than the provision of labor services, may be applicable.

Repair components (parts and materials), but not consumables, provided during a repair, or purchased individually, are warranted for 90 days ex-works for materials and workmanship. In no event will the incorporation of a warranted repair component into an instrument extend the whole instrument's warranty beyond its original term.

### **Warranty Shipping**

A Repair Authorization (RA) Number must be obtained from Pyxis Technical Support before any product can be returned to the factory. Pyxis will pay freight charges to ship replacement or repaired products to the customer. The customer shall pay freight charges for returning products to Pyxis. Any product returned to the factory without an RA number will be returned to the customer. To receive an RMA you can generate a request on our website at <https://pyxis-lab.com/request-tech-support/>.

### **Pyxis Technical Support**

Contact Pyxis Technical Support at +1 (866) 203-8397, [service@pyxis-lab.com](mailto:service@pyxis-lab.com), or by filling out a request for support at <https://pyxis-lab.com/request-tech-support/>.

## 1 Introduction

The Pyxis EM-500 inline fluorometer (470 nm excitation and 675 nm emission) measures the in-vivo chlorophyll-a concentration of live algae cells present in water. Chlorophyll-a is the primary photosynthetic pigment of algae and fluoresces when exposed to proper wavelength. Chlorophyll-a measurement can be used to assess algal biomass of the bulk water in numerous industrial and process related applications. The fluidic and optical arrangement of the EM-500 sensor is designed to overcome many shortcomings associated with other inline fluorometers by compensating for both color (as high as 10 ppm iron) and turbidity (as high as 150 NTU) present in the sample water.

The EM-500 sensor can come with a custom mounting tee which has two 3/4" female NPT or socket ports for plumbing into an existing 3/4" sample water line and can also be installed to a large tank or a body of water using the Pyxis Submersible Adapter (MA-102S). Additional mounting tee line sizes are available from Pyxis Lab. The EM-500 sensor can be connected to any device that accepts an isolated or non-isolated 4–20mA input or RS-485 Modbus. The EM-500 sensor has a short fluidic channel that can be easily cleaned as referenced in the **Methods to Cleaning the EM-500 Sensor** section of this manual.

The EM-500 sensor is pre-calibrated using a live algae sample. The fluorescence chlorophyll-a measurement is automatically compensated for sample color and turbidity interference. The EM-500 can be calibrated using a water sample with known chlorophyll-a concentration or a simulated 470 nm/675 nm (Excitation/Emission) fluorescent sample through the user-friendly **uPyxis®** App for both mobile devices and desktop. Diagnostic information (sensor fouling, color or turbidity over range, failure modes) can be communicated to digital displays via Modbus RTU as well as via **uPyxis®** App. The EM-500 sensor can be easily removed from the custom tee for cleaning without the need for any tools.

## 2 Specifications

**Table 1.** EM-500 Specifications

| Item                            | Specification*   |
|---------------------------------|--|
| Part Number (P/N)               | 50501  |
| Chlorophyll-a Range             | 0.1–50 ppb   |
| Chlorophyll-a Resolution        | 0.2 ppb  |
| Excitation/Emission Wavelengths | 470 nm/675 nm  |
| Calibration                     | Two-point calibration against standard solution                  |
| Outputs                         | 4–20mA Analog Output, RS-485 Digital Output with Modbus protocol |
| Installation                    | <b>Pipeline Installation, Submersed Installation</b>             |
| Cable Length                    | 5 ft with IP67 connectors  |
| Power Supply                    | 22–26 VDC, 1W  |
| Dimension (L × Dia)             | 6.8 × 1.44 inch (172.7 × 36.6 mm)                                |
| Weight                          | 0.37 lbs (170 g)   |
| Material                        | CPVC   |
| Operational Temperature         | 40–104 °F (4–40 °C)  |
| Storage Temperature             | 20–140 °F (-7–60 °C)   |
| Pressure                        | Up to 100 psi (0.7 MPa)  |
| Enclosure Rating                | IP67   |
| Regulation                      | CE   |

\* With Pyxis's continuous improvement policy, these specifications are subject to change without notice.

## 3 Unpacking Instrument

Remove the instrument and accessories from the shipping container and inspect each item for any damage that may have occurred during shipping. Verify that all accessory items are included. If any item is missing or damaged, please contact Pyxis Lab Customer Service at [service@pyxis-lab.com](mailto:service@pyxis-lab.com).

### 3.1 Standard Accessories

- Tee Assembly 3/4" NPT (1x Tee, O-ring, and Nut) P/N: ST-001
- 7-Pin Female Adapter/Flying Leads Cable (2 ft) P/N: MA-1100
- User Manual available online at <https://pyxis-lab.com/support/>

### 3.2 Optional Accessories

The following optional accessories can be ordered from Pyxis Customer Service ([order@pyxis-lab.com](mailto:order@pyxis-lab.com)) or Pyxis E-Store at <https://pyxis-lab.com/shop/>.

|  <b>PYXIS INLINE SENSOR ACCESSORIES - SELECT*A*GUIDE</b>  |             |   |
|---|-------------|---|
| Accessory Name/Description  | Part Number | Photo   |
| Pyxis ST Series Cleaning Kit<br><i>(includes 500mL Sensor Cleaner / Qtips &amp; Pipe Cleaners)</i>  | SER-01      |    |
| Chlorophyll-a Calibration Standard Solution - 20ppb   | 57012       |    |
| 0.75" NPT Inline Sensor Tee Assembly <i>(All ST Series Sensors)</i>   | 50704       |    |
| 2.0" NPT Inline Sensor Tee Assembly <i>(All ST Series Sensors)</i>  | 50756       |   |
| 3.0" NPT Inline Sensor Tee Assembly <i>(All ST Series Sensors)</i>  | 50775       |   |
| ST-002 Inline Sensor Removal PLUG <i>(Allows ST Sensor Removal)</i>   | ST-002      |    |
| ST Series Sensor Tee Replacement O-Ring <i>(All ST Series Tee's)</i>  | MA-150      |    |
| ST Series Submersion Adapter Kit<br><i>(Submersible Kit for all ST-Series Sensors)</i>  | MA-102S     |  |
| MA-WB Bluetooth Adapter for All ST Series Sensors<br><i>(4-20mA &amp; RS-485)</i>   | MA-WB       |  |
| MA-485 USB Adapter for All ST Series Sensors<br><i>(4-20mA RS-485)</i>  | MA-485      |  |
| Bluetooth PC to Handheld Adapter <i>(For uPyxis Firmware Updates)</i>   | MA-NEB      |  |
| PowerPack 1 <i>(Single Channel Power Supply w/Bluetooth)</i>  | MA-BLE-1    |  |
| PowerPack 4 <i>(Four Channel Power Supply w/Bluetooth)</i>  | MA-BLE-4    |  |
| MA-1100 <i>(24' Flying Lead Cable for All ST Sensors)</i>   | MA-1100     |  |
| MA-C10 <i>(10' Extension Cable for All ST Sensors)</i>  | 50738       |  |
| MA-C50 <i>(50' Extension Cable for All ST Sensors)</i>  | 50705       |   |

Figure 1.

## 4 Installation

### 4.1 Pipeline Installation

The provided ST-001 Tee Assembly can be connected to a pipe system through the 3/4" female ports, either socket or NPT threaded. To properly install the EM-500 sensor into the ST-001 Tee Assembly, follow the steps below:

1. Insert the provided O-ring into the O-ring groove on the tee.
2. Insert the EM-500 sensor into the tee.
3. Tighten the tee nut onto the tee to form a water-tight, compression seal.

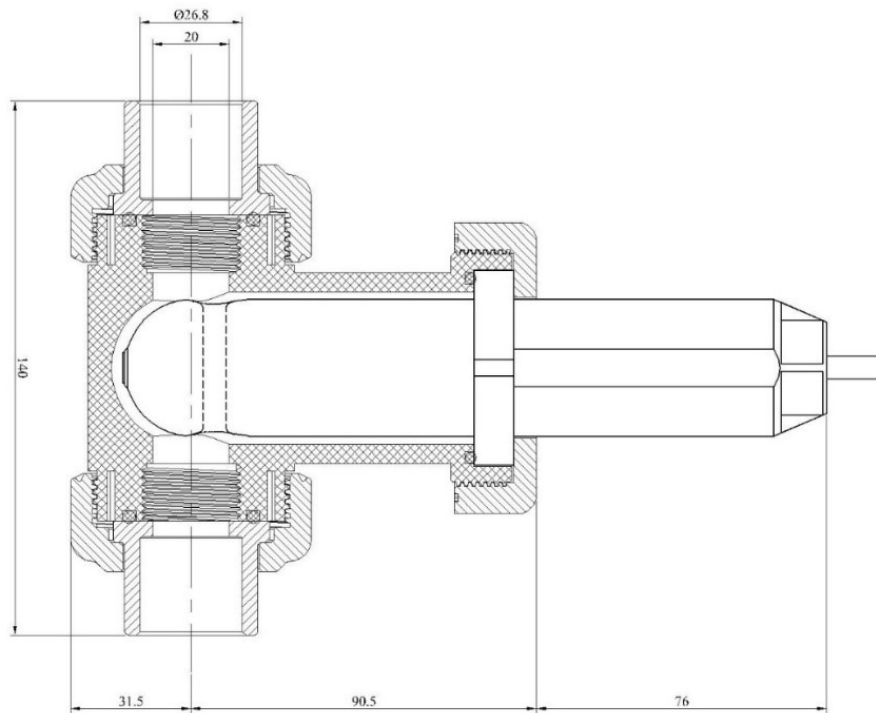

**Figure 2.** Dimension of the EM-500 and the ST-001 Tee Assembly (mm)



### 4.2 Submersed Installation

The EM-500 sensor can be submersed into a tank using the ST Series Submersion Adapter Kit (P/N: MA-102S). The assembly of the kit is illustrated in Figure 3.

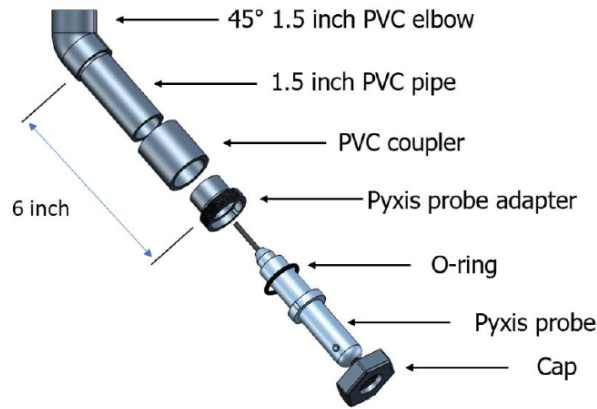

Figure 3. Schematic of the MA-102S Submersion Adapter Installation

### 4.3 Wiring

If the power ground terminal and the negative 4–20mA terminal in the controller are internally connected (non-isolated 4–20mA input), it is unnecessary to connect the 4–20mA negative wire (green) to the 4–20mA negative terminal in the controller. If a separate DC power supply other than that from the controller is used, make sure that the output from the power supply is rated for 22–26 VDC @ 65mA.

**\*NOTE\*** *The negative 24V power terminal (power ground) and the negative 4–20mA terminal on the EM-500 sensor are internally connected.*

Follow the wiring table below to connect the EM-500 sensor to a controller:

Table 2.

| Wire Color | Designation          |
|------------|----------------------|
| Red        | 24V +                |
| Black      | 24V Power ground     |
| White      | 4–20mA +             |
| Green*     | 4–20mA -             |
| Blue       | RS-485 A             |
| Yellow     | RS-485 B             |
| Clear      | Shield, earth ground |

\* Internally connected to the power ground

#### 4.4 Connecting via Bluetooth

A Bluetooth adapter (P/N: MA-WB) can be used to connect a EM-500 sensor to a smart phone with the **uPyxis®** Mobile App or a computer with a Bluetooth/USB Adapter (P/N: MA-NEB) and the **uPyxis®** Desktop App. The power should be sourced from a 24 VDC power terminal of a controller. If a controller is not available, please purchase a Pyxis PowerPack-1 (P/N: MA-BLE-1) or PowerPack-4 (P/N: MA-BLE-4) auxiliary power supply with Bluetooth, or an alternative 24 V power supply that can directly connect to the EM-500 sensor with proper cable connectors from Pyxis.



Figure 4. Bluetooth connection to EM-500 sensor

#### 4.5 Connecting via USB

A USB-RS485 adapter (P/N: MA-485) can be used to connect a EM-500 sensor to a computer with the **uPyxis®** Desktop App.

**\*NOTE\*** Using non-Pyxis USB-RS485 adapters may result in permanent damage of the EM-500 sensor communication hardware.

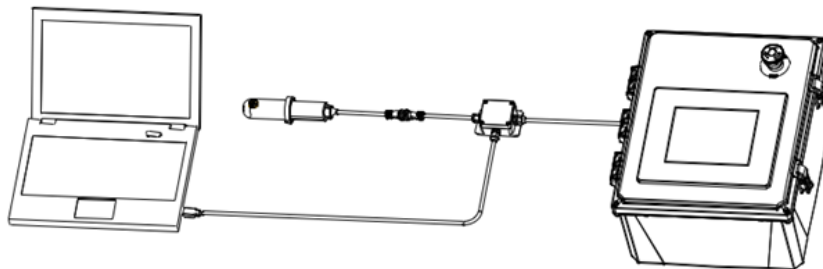

Figure 5. USB connection to EM-500 sensor

## 5 Setup and Calibration with uPyxis® Mobile App

The EM-500 sensor is calibrated with a live cyanobacteria sample before shipping. The chlorophyll-a concentration in the live algae is measured using the traditional spectrophotometric method. The EM-500 sensor can be calibrated by the user using any water sample with a known chlorophyll-a concentration. Alternatively, the EM-500 sensor can be calibrated against a chemical standard to simulate the chlorophyll-a fluorescent characteristic. Chlorophyll-a by itself is not stable and not suitable to be used as a field calibration solution due to rapid degradation. A simulated/synthetic calibration standard (Pyxis CHLORO-20) is recommended to bring the fluorometer back to the factory calibration. In some unique cases, the user may desire to utilize their own living chlorophyll-a standard, which can easily be done using the **uPyxis®** Mobile App for wireless diagnostics, cleaning and calibration.

The calibration procedure provided in this manual is based on using the Pyxis chlorophyll-a 20 ppb calibration standard (P/N: 57012). This is a synthetic standard simulating a concentration of 20 ppb as in-vivo chlorophyll-a. The user can also use any sample that has a known chlorophyll-a concentration determined by traditional spectrophotometric methods to carry out the calibration as mentioned above.

### 5.1 Download uPyxis® Mobile App

Download **uPyxis®** Mobile App from [Apple App Store](#) or [Google Play](#).

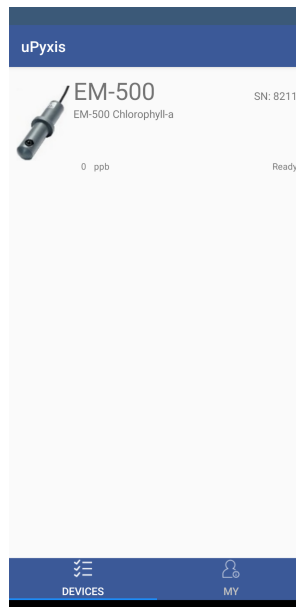

Figure 6. uPyxis® Mobile App installation

## 5.2 Connecting to uPyxis® Mobile App

Connect the EM-500 sensor to a mobile smart phone according to the following steps:

1. Open **uPyxis®** Mobile App.
2. On **uPyxis®** Mobile App, pull down to refresh the list of available Pyxis devices.
3. If the connection is successful, the EM-500 and its Serial Number (SN) will be displayed (Figure 7).
4. Press on the **EM-500 sensor image**.



**Figure 7.**

### 5.3 Calibration Screen and Reading

When connected, the uPyxis® Mobile App will default to the **Calibration** screen. From the **Calibration** screen, you can perform calibrations by pressing on **Zero Calibration**, **Slope Calibration**, and **4-20mA Span**. Follow the screen instructions for each calibration step.

**\*NOTE\*** For best results, the chlorophyll-a standard should be in the range of 20 to 50 ppb.

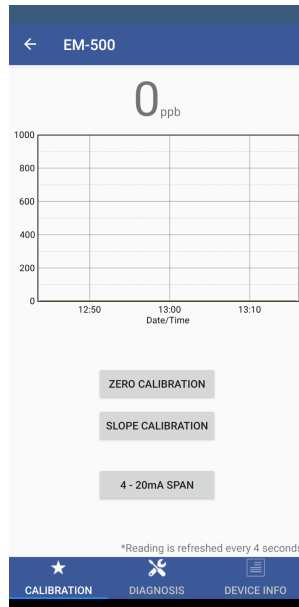

Figure 8.

### 5.4 Diagnosis Screen

From the **Diagnosis** screen, you can check the diagnosis condition as well as **Export & Upload**. This feature may be used for technical support when communicating with [service@pyxis-lab.com](mailto:service@pyxis-lab.com).

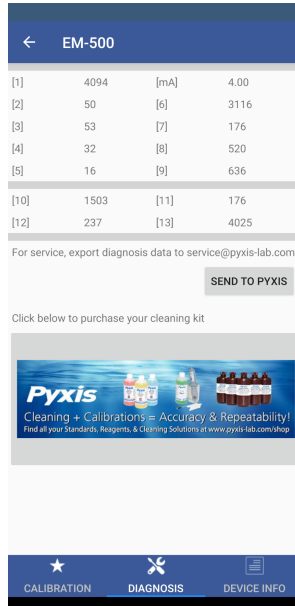

Figure 9.

### 5.5 Device Info Screen

From the **Device Info** screen. You can name the Device or Product.

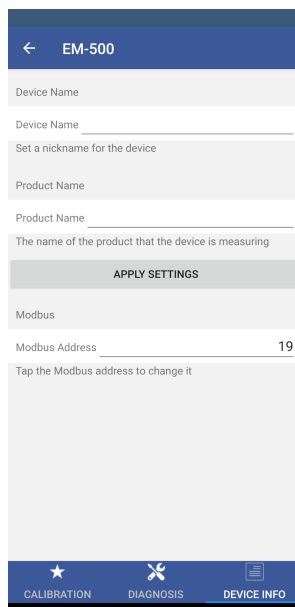

Figure 10.

## 6 Setup and Calibration with uPyxis® Desktop App

The EM-500 sensor is calibrated with a live cyanobacteria sample before shipping. The chlorophyll-a concentration in the live algae is measured using the traditional spectrophotometric method. The EM-500 sensor can be calibrated by the user using any water sample with a known chlorophyll-a concentration. Alternatively, the EM-500 sensor can be calibrated against a chemical standard to simulate the chlorophyll-a fluorescent characteristic. Chlorophyll-a by itself is not stable and not suitable to be used as a field calibration solution due to rapid degradation. A simulated/synthetic calibration standard (Pyxis CHLORO-20) is recommended to bring the fluorometer back to the factory calibration. In some unique cases, the user may desire to utilize their own living chlorophyll-a standard, which can easily be done using the **uPyxis®** Mobile App for wireless diagnostics, cleaning and calibration.

The calibration procedure provided in this manual is based on using the Pyxis chlorophyll-a 20 ppb calibration standard (P/N: 57012). This is a synthetic standard simulating a concentration of 20 ppb as in-vivo chlorophyll-a. The user can also use any sample that has a known chlorophyll-a concentration determined by traditional spectrophotometric methods to carry out the calibration as mentioned above.

### 6.1 Install uPyxis® Desktop App

Download the latest version of **uPyxis®** Desktop software package from: <https://pyxis-lab.com/upyxis/> this setup package will download and install the Microsoft.Net Framework 4.5 (if not previously installed on the PC), the USB driver for the USB-Bluetooth adapter (MA-NEB), the USB-RS485 adapter (MA-485), and the main **uPyxis®** Desktop application. Double click the **uPyxis.Setup.exe** file to install.

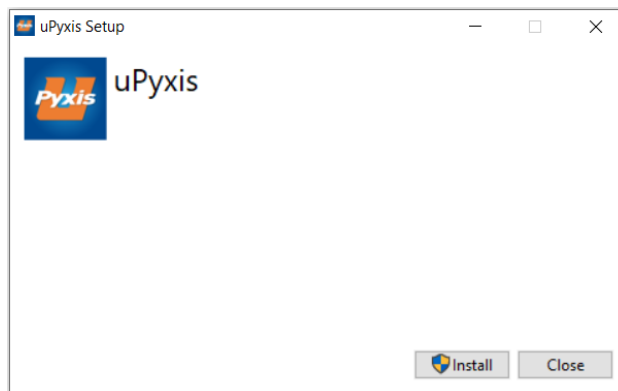

**Figure 11.** uPyxis® Desktop App installation

Click **Install** to start the installation process. Follow the screen instructions to complete the USB driver and uPyxis installation.

## 6.2 Connecting to uPyxis® Desktop App

Connect the EM-500 sensor to a Windows computer using either a Bluetooth/USB adapter (P/N: MA-NEB) or a USB-RS485 adapter (P/N: MA-485) according to the following steps:

1. Plug the Bluetooth/USB adapter or USB-RS485 adapter into a USB port in the computer.
2. Launch **uPyxis®** Desktop App.
3. On **uPyxis®** Desktop App, click Device → **Connect via USB-Bluetooth** or **Connect via USB-RS485** (Figure 12).
4. If the connection is successful, the EM-500 and its Serial Number (SN) will be displayed in the left pane of the **uPyxis®** window.

**\*NOTE\*** After the sensor and Bluetooth is powered up, it may take up to 10 seconds for the adapter to establish the wireless signal for communication.

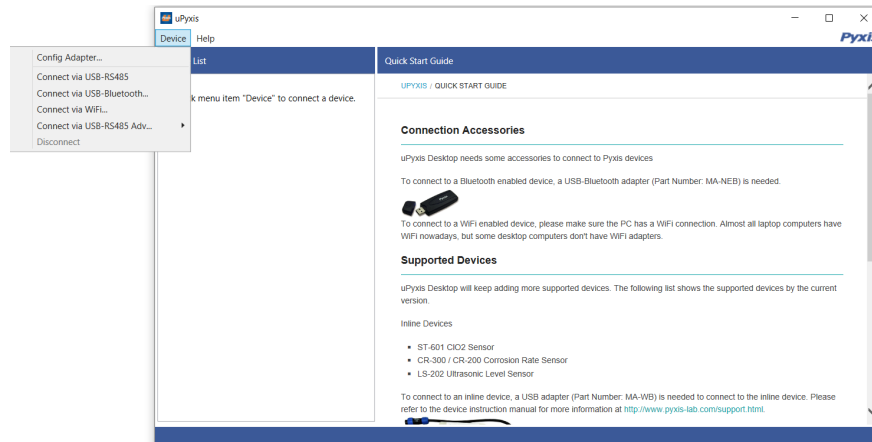

Figure 12.



### 6.3 Information Screen

Once connected to the device, a picture of the device will appear on the top left corner of the window and the uPyxis® Desktop App will default to the **Information** screen. On the **Information** screen you can set the information description for **Device Name** and **Product Name**, then click **Set** to save.

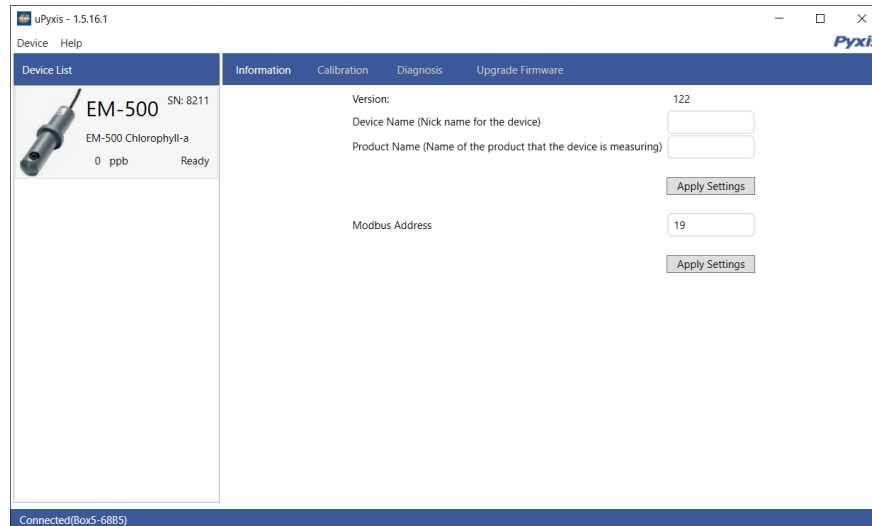

Figure 13.

### 6.4 Calibration Screen

To calibrate the device, click on **Calibration**. On the **Calibration** screen there are three calibration tabs, **Zero Calibration**, **Slope Calibration**, and **4-20mA Span**. The screen also displays the reading of the device. The reading refresh rate is every 4 seconds. Follow the screen instructions for each calibration step.

**\*NOTE\*** For best results, the chlorophyll-a standard should be in the range of 20 to 50 ppb.

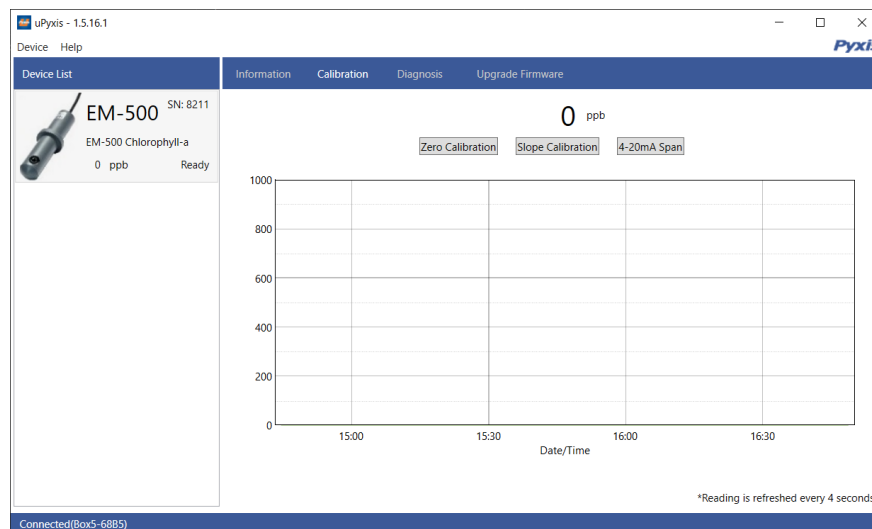
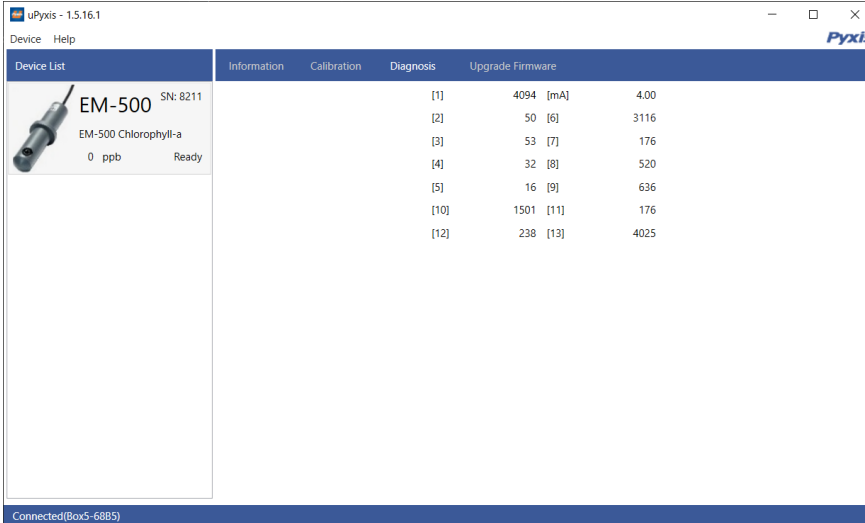

Figure 14.

## 6.5 Diagnosis Screen

After the device has been calibrated and installation has been completed, to check diagnosis, click on **Diagnosis**. When in the **Diagnosis** screen you can view the Diagnosis Condition of the device. This feature may be used for technical support when communicating with [service@pyxis-lab.com](mailto:service@pyxis-lab.com).



| Device List   | Information | Calibration | Diagnosis   | Upgrade Firmware |
|---|-------------|-------------|---|------------------|
|  <b>EM-500</b> SN: 8211<br>EM-500 Chlorophyll-a<br>0 ppb Ready |             |             | [1] 4094 [mA] 4.00<br>[2] 50 [6] 3116<br>[3] 53 [7] 176<br>[4] 32 [8] 520<br>[5] 16 [9] 636<br>[10] 1501 [11] 176<br>[12] 238 [13] 4025 |                  |

Figure 15.

## 7 Outputs

### 7.1 4–20mA Output Setup

The 4–20mA output of the EM-500 sensor is scaled as:

- Chlorophyll-a:
  - 4 mA = 0 ppb
  - 20 mA = 50 ppb

## 7.2 Adjusting 4–20mA Span

Users may adjust the output scale using 4–20mA Span to change the chlorophyll-a value corresponding to the 20 mA output via **uPyxis**<sup>®</sup>. For the **uPyxis**<sup>®</sup> Mobile App, press **4-20mA Span** found on the **Calibration and Reading Screen**, shown in Figure 16. For the **uPyxis**<sup>®</sup> Desktop App, click **4-20mA Span** found on the **Calibration Screen**, shown in Figure 17.

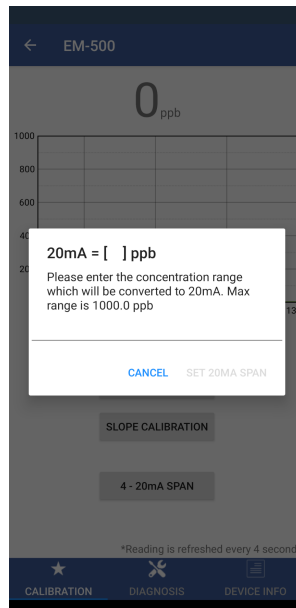

Figure 16.

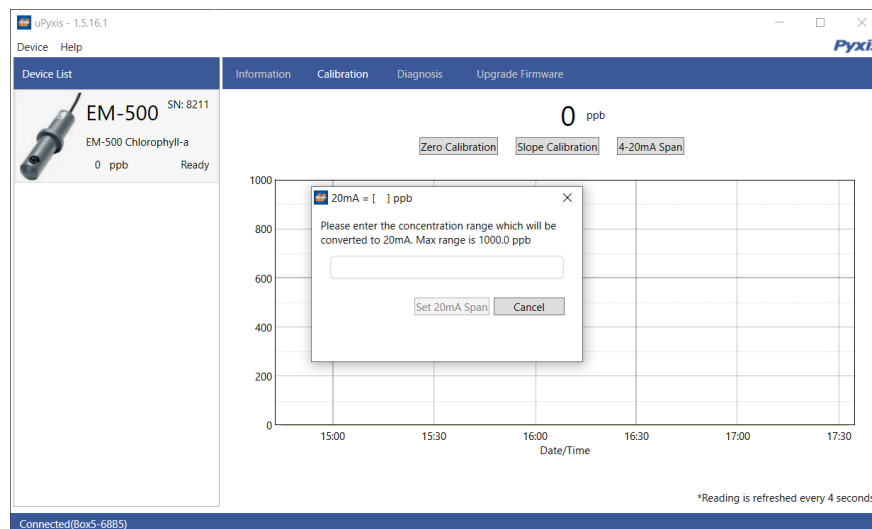

Figure 17.

## 7.3 Communication using Modbus RTU

The EM-500 sensor is configured as a Modbus slave device. In addition to the chlorophyll-a ppb value, many operational parameters, including warning and error messages, are available via a Modbus RTU connection. Contact Pyxis Lab Customer Service ([service@pyxis-lab.com](mailto:service@pyxis-lab.com)) for more information.

## 8 Sensor Maintenance and Precaution

The EM-500 sensor is designed to provide reliable and continuous chlorophyll-a readings even when installed in moderately contaminated industrial cooling waters. Although the optics are compensated for the effects of moderate fouling, heavy fouling will prevent the light from reaching the sensor. This results in low readings and the potential for product under or over feed if the EM-500 sensor is used as part of an automated control system for algacide dosing. When used to control product dosing, it is suggested that the automation system be configured to provide backup to limit potential product under or over feed situations, for example by limiting pump size or duration, or by alarming if the pumping rate exceeds a desired maximum limit.

The EM-500 sensor is designed to be easily removed, inspected, and cleaned if required. The EM-500 sensor should be checked for fouling and cleaned on a monthly basis. Heavily contaminated waters may require more frequent cleanings. Cleaner water sources with less contamination may not require cleaning for several months.

### 8.1 Methods to Cleaning EM-500 Sensor

Any equipment in contact with industrial cooling systems is subject to many potential foulants and contaminants. Our inline sensor cleaning solutions below have been shown to remove most common foulants and contaminants. A small, soft bristle brush, Q-Tips cotton swab, or soft cloth may be used to safely clean the sensor housing and the quartz optical sensor channel. These components and more come with a Pyxis Lab **Inline Probe Cleaning Solution Kit** (P/N: SER-01) which can be purchased at our online E-Store <https://pyxis-lab.com/product/st-series-probe-cleaning-kit/>



**Figure 18.** Inline Probe Cleaning Solution Kit

If deposits are **organic or biological** in nature, Pyxis recommends users create their own cleaning solution utilizing Dawn dish detergent, warm water, and a few mL of household bleach (establishing 50 ppm + FCl<sub>2</sub>). This solution should work well for removal of bio-slime and organic deposits.

To clean the EM-500 sensor, soak the lower half of the sensor in 100 mL inline sensor cleaning solution for 30 minutes. Rinse the EM-500 sensor with distilled water and then check for the flashing blue light inside the EM-500 sensor quartz tube. If the surface is not entirely clean, continue to soak the EM-500 sensor for an additional 30 minutes. Use the small, soft bristle brush and Q-Tips cotton swabs as necessary to remove any remaining contaminants in the EM-500 sensor quartz tube.

## 8.2 Storage

Avoid long term storage at temperature over 100 °F. In an outdoor installation, properly shield the EM-500 sensor from direct sunlight and precipitation.

## 9 Troubleshooting

If the EM-500 sensor output signal is not stable and fluctuates significantly, make an additional ground connection — connect the clear (shield, earth ground) wire to a conductor that contacts the sample water electrically such as a metal pipe adjacent to the EM-500 sensor tee.

Carry out routine calibration verification against a qualified chlorophyll-a standard. After properly cleaning the EM-500 sensor, carry out the zero point and slope calibration using the qualified chlorophyll-a standard. Pyxis Lab **Chlorophyll-a 20 ppb Standard** can be purchased at our online E-Store <https://pyxis-lab.com/product/chlorophyll-a-20-ppb-calibration-standard/>



**Figure 19.** Chlorophyll-a 20 ppb Standard

## 10 Contact Us

**Pyxis Lab, Inc**

1729 Majestic Dr. Suite 5

Lafayette, CO 80026 USA

[www.pyxis-lab.com](http://www.pyxis-lab.com)

Phone: +1 (866) 203-8397

Email: [service@pyxis-lab.com](mailto:service@pyxis-lab.com)