



RAILWAY INDUSTRY by **celduc**[®] relais

www.celduc-relais.com

DESIGNER &
MANUFACTURER OF
SOLID STATE RELAYS
FOR THE RAILWAY
INDUSTRY

RAILWAY APPLICATIONS :
ROLLING STOCK, SIGNALLING
& ACCESSORIES ON TRAINS





• Interface relays



• PCB relays



• Single phase SSR and optional modules for diagnostic function



• Two phase Solid State Relays



THE ONLY SOLID STATE RELAY TECHNOLOGY
made in France for more than 50 years !



• Three phase Solid State Relays

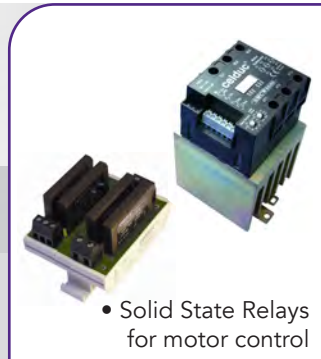

• Solid State Relays for motor control



• Phase angle controllers



• DC Solid State Relays

Large temperature variations, shocks, vibrations, electromagnetic interferences, and more : electrical components for the railway industry must provide safe and reliable operation even under extreme conditions.

celduc® relais has developed its SSRs with the highest quality standards.

We have been a reliable and experienced partner in the railway industry for many years.

You can rely on our solutions !

■ **SOLID STATE RELAYS AC OR DC** FOR LOAD SWITCHING IN THE RAILWAY INDUSTRY

→ AC switching up to 125A / 690VAC

→ DC switching up to 50A / 1700Vp
or 150A / 100Vp

→ Diagnostic capabilities and over voltage protection available

ENERGY SAVING & RELIABILITY

SSRs FOR EVERY APPLICATION AREA

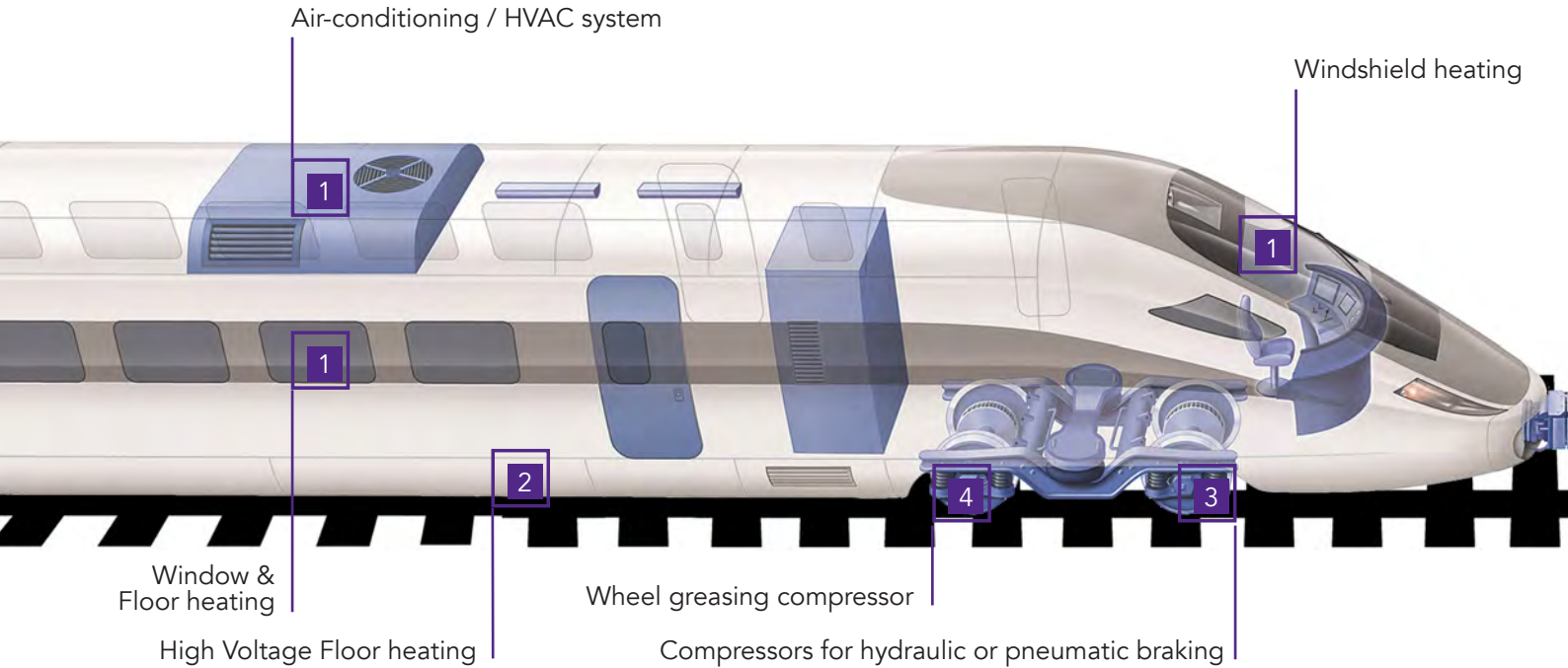

CONTENTS

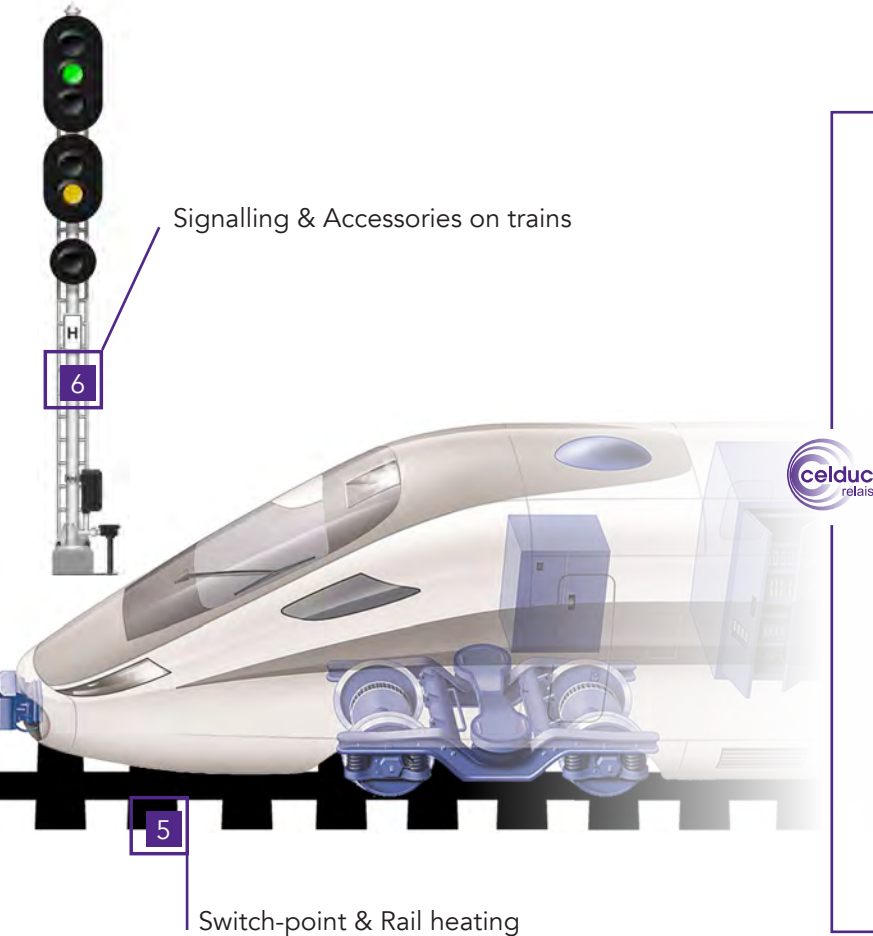

■	Who are we ?	4 - 5
1	HVAC system Floor / Window heating	6 - 7
2	High Voltage Floor Heating	8 - 9
3	Compressors for hydraulic or pneumatic braking	10 - 11
4	Streetcar wheel greasing compressor	12 - 13
5	Switch-point & Rail heating	14 - 17
6	Signalling & Accessories	18 - 19
cel3pac	New 3-phase SSRs	20 - 21
	EMR vs SSR	22
■	Why choose celduc ?	23 - 24

WHO ARE WE ?

celduc® group specializes in electrical engineering and electronics.

With many years of experience **celduc®** is fully focused on serving its market and customers all over the world. The company was founded in 1964 by Michel Guichard. Set up near Saint-Etienne, the **celduc® group** is the only French company producing and selling solid state relays. Today **celduc® group** group has:

- 200 employees
- Two production centers totaling 10 000 square meters
- A worldwide presence

A strong innovation to challenge the future

celduc® relais product development and commitment to work with customers to develop custom solutions helps to increase our production capacity by around 10 to 15 % per year.

Innovation is the challenge that **celduc® relais** takes up every day by anticipating the market trends and implementing specific knowledge and skills in partnership with industry and research.

From design to manufacturing

celduc® relais controls the complete chain : design, development, production, testing and marketing.

celduc® relais manufactures a comprehensive range of Solid State Relays but has also developed its own production equipment to ensure the most efficient manufacturing methods.

Thanks to this high-capacity and unique tooling, **celduc®** products can be found all over the world and have been recognized by the most renowned industrial companies.

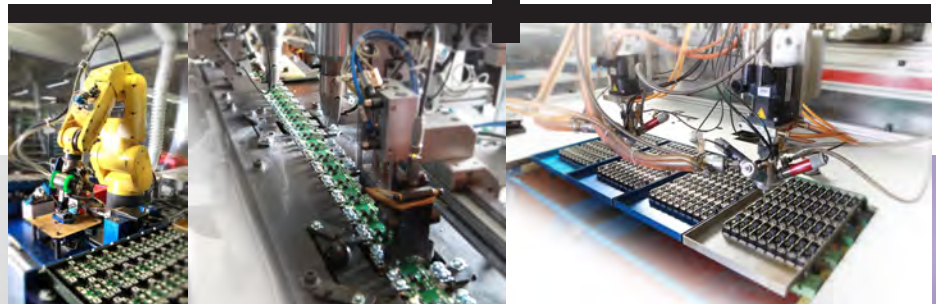

HIGH QUALITY PRODUCTS



Quality is of paramount importance and maintained at all times, aided by our own specially developed in house testing equipment. **celduc® relais** solid state relays and magnetic sensors are manufactured in accordance with major international standards (UL, CSA, EN, VDE, CE, ATEX, ...)...



pending



All products are designed, tested and manufactured in compliance with the strictest international standards and always with reliability and safety in mind

The solutions displayed in this brochure represent some of the applications our products are used in.



Air-conditioning / HVAC system
Floor heating
Windows / Windshield heating

MANY OF THE WORLD'S LARGEST ROLLING STOCK
MANUFACTURERS RELY ON OUR PRODUCTS

6

7

celpac[®] 2G

The 22,5mm pitch SSR solution !

Reference	Thyristor rating	Max. switching current at 25°C	Switching voltage	Peak voltage	Control voltage	I ² t
SUL865970	50A	32A	24-510VAC	1200V	160-240VAC	1 680A ² s
SUL867070	75A	35A	24-510VAC	1200V	3,5-32VDC	7 200A ² s



Optional Modules ESUC & ECOM

Add a diagnostic function to our SUL SSR

Reference	Specifications	Current range	Control voltage
ESUC0450	Current monitoring module	2-40A	8-30VDC
ESUC0480	Current monitoring module	2-40A	24-45VDC
ECOM0010	Temperature controller PID, current monitor and communication interface		



Status feedback for safety - Save space - Save costs
Add functions !

okpac[®]

High voltage single phase Solid State Relays

Reference	Thyristor rating	Switching voltage	Peak voltage	Control voltage	I ² t
SO885960	50A	24-690VAC	1600V	20-265VAC/DC	2 800A ² s
SO889060	125A	24-690VAC	1600V	3,5-32VDC	22 000A ² s



Other models available please visit our website www.celduc-relais.com

High Voltage Floor Heating

AT CELDUC® RELAIS,
DC POWER SWITCHING UNDER CONTROL !

8

9



DC SSR – IGBT Technology

50A-750Vdc fully protected HV DC SSR for controlling HV floor heaters supplied directly from the catenary

Our IGBT based SDI SSR can switch 50 A @ 750 VDC nominal in a fast, reliable and safe way. In every situation, safety operation is preserved :

- Built-in over-voltage protection for inductive DC supply lines (max L/R = 20ms), OV4
- Built-in load short circuit protection : by detection of IGBT saturation, short circuits on the load will block the unit, keeping it safe
- Built-in over load temperature protection : should over-heating occur, the unit will automatically switch off
- Status feedback for Safety
- HL2 (Hazard Level EN 45545-2)



The SDI SSR is designed for the most demanding DC power switching Applications. The features of this product make it an attractive solution for many rail applications.

Reference	Switching current	Switching voltage	Peak voltage	Control voltage	Integrated protection
SDI0501700	50A	24-940VDC	1700V	16,8-24VDC	- over-voltage protection - load short circuit protection - over-load temperature protection
SDI0501710	50A	24-940VDC	1700V	72-110VDC	
SDI1001700	100A	24-940VDC	1700V	24-48VDC	

Other models available please visit our website www.celduc-relais.com

Compressors for hydraulic or pneumatic braking

INNOVATION AND QUALITY IS WHAT DRIVES OUR
NEW PRODUCT DEVELOPMENT.



10

11

- This range is designed for all types of loads from 12 to 125A
- Output voltage from 24 to 690VAC (600V – 1200V – 1600V peak)
- 4th generation TMS² technology results in long product lifetime

Hydraulic and pneumatic braking systems are composed of pumps and compressors.

Our SSRs are used for controlling these compressors.

Our okpac® range is one of the solutions we offer but others are available, depending on the system design. Contact us to discuss your specific application.



Reference	Thyristor rating	Switching voltage	Peak voltage	Control voltage	I ² t	Dimensions mm
SO885960	50A	24-690VAC	1600V	20-265VAC/DC	2 800A ² s	45 x 58,5 x 30
SO867070	75A	24-510VAC	1200V	3,5-32VDC	7 200A ² s	

For status feedback for safety, the solution with SSRs is to add a diagnostic function.

celduc® relais offers a range of Power SSRs with diagnostics capabilities.



Reference	Thyristor rating	Switching voltage	Peak voltage	Control voltage	I ² t	Dimensions mm
SOD845180	50A	50-265VAC	600V	7-30VDC	2 800A ² s	45 x 58,5 x 33,6
SOD867180	75A	150-510VAC	1200V	7-30VDC	7 200A ² s	

Other models available please visit our website www.celduc-relais.com

Streetcar wheel greasing compressor

FOR EACH APPLICATION,
THE CORRESPONDING TECHNOLOGY !

12

13



DC SSR – MOSFET Technology

DC Solid State Relays for motor control

celduc® relais offers a complete range of DC solid state relays up to 1700Vdc, 0 to 150A for DC applications. Our DC SSRs are used to control wheel greasing compressors.



SCM range



SOM range + voltage protection ESO01000



This system is designed for lubricating the wheel flanges of streetcars. The system works on the principle of applying a lubricant mixture to the contact area between the wheel flanges and the rails by means of pressurized air.

Reference	Switching current	Switching voltage	Peak voltage	Control voltage	Integrated protection	Dimensions mm
SCM0100200	100A	0-200VDC	200V	4,5-32VDC	-	44,5 x 58,2 x 27
SCM0150100	150A	0-100VDC	100V	4,5-32VDC	-	
SOM040200	40A	5-110VDC	200V	3,5-32VDC	Transil	45 x 58,5 x 30
SOM06075	60A	5-40VDC	75V	3,5-32VDC	Transil	
ESO01000	0-80A	0-130VDC	200V	Protection against line inductance (C1, D2) : option for SOM range	Diode + capacitor	

Other models available please visit our website www.celduc-relais.com

Railway Switch-point heating

WORLD LEADER IN SOLID-STATE POWER SWITCHING
& CONTROL !

14

15





In climatic regions which frequently experience temperatures below freezing, malfunctions of railroad rail switch mechanisms is often a problem. Temperatures below freezing and the accumulation of snow and ice result in issues with railroad switch mechanisms.

The solution is railroad switch heaters.

Our SSRs are used to control these electric switch heaters. As shown below, the system is equipped for automatic operation and include snow detectors and temperature sensors.

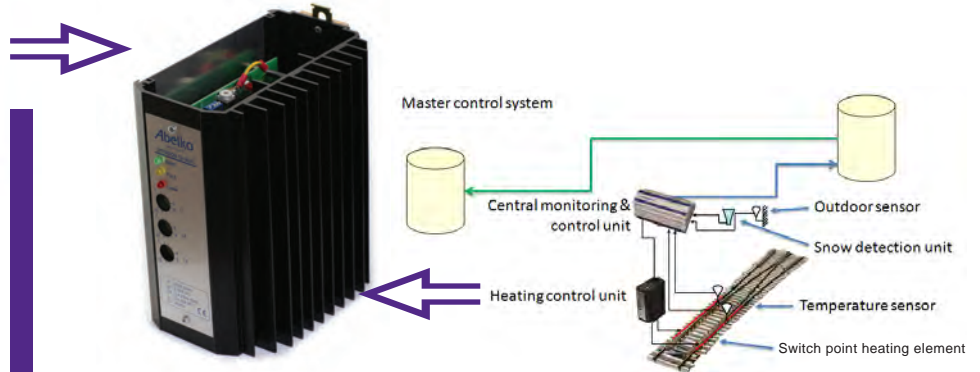

The use of celduc's SO range allows this system to operate reliably.

Other models available
please visit our website
www.celduc-relais.com



Railway switch-point motors

WORLD LEADER IN SOLID-STATE POWER SWITCHING
& CONTROL !

16

17

Motor control can be a challenging task due to characteristics such as high inductive loads combined with high starting currents and over voltage conditions.

As a result Solid State solutions are often used to control motor loads.

celduc's Solid State Relays offer some of the best solutions to cover all of the above mentioned requirements.

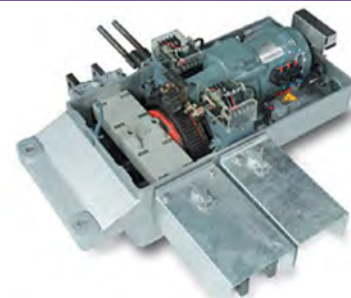

This specific application uses five high voltage AC SSR, for motor reversing.

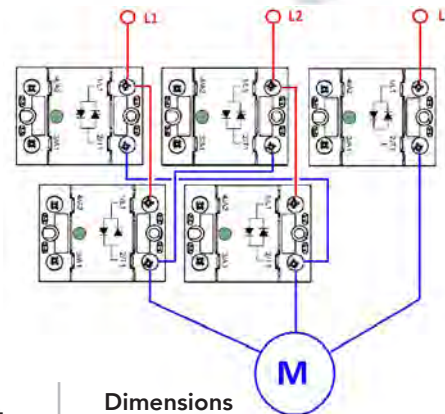

Reference	Thyristor rating	Switching voltage	Peak voltage	Control voltage	I ² t	Dimensions mm
SO887060	75A	24-690VAC	1600V	3,5-32VDC	7 200A ² s	45 x 58,5 x 30

Other models available please visit our website www.celduc-relais.com



Signalling & Accessories on trains

CELDUC® RELAIS, THE ONLY SSR TECHNOLOGY
MADE IN FRANCE FOR MORE THAN 40 YEARS !

18

19

PCB RELAYS

Interface Solid State Relays AC or DC For all types of loads

celduc® relais offers a wide range of Interface Solid State Relays

- **SKA range** (AC output) up to 6A 230 or 400VAC, with built-in voltage protection
- **SKD range** (DC output – Bipolar technology) up to 3A 60VDC or 200VDC and SKLD range (DC output – MOSFET technology) up to 12A 36VDC or 60VDC

Both ranges are complemented with other products including a ceramic substrate (DCB technology : Direct Copper Bonding) :

- **SKL range** can be mounted on a heatsink and supports currents from 16A to 75A.
- **SKH range** if used with integrated heatsink and additional ventilation can support currents up to 25A.

DCB technology (Direct Copper Bonding) combined with the TMS² technology (Thermo-Mechanical Stress Solution) considerably improve life-time thanks to the reduction of thermal stress.

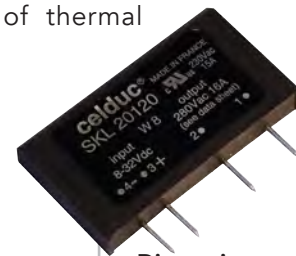

Reference	Thyristor rating	Switching voltage	Control voltage	I ² t	Specifications	Dimensions mm
SK541101	2,5A	24-280VAC	3-30VDC	50A ² s	AC zero-cross output / normally closed	40x11x21
SKA10420	5A	12-275VAC	2,5-10VDC	50A ² s	AC zero-cross output / most types of loads	43,2x10,2x25,4
SKA20441	5A	12-460VAC	4-30VDC	50A ² s	AC random output / most types of loads	
SKL10560	50A	24-690VAC	4-14VDC	1800A ² s	AC zero-cross output	43,4x6,3x24,5
SKL20740	75A	24-600VAC	8-32VDC	5000A ² s	AC zero-cross output	
SKL10521	50A	12-280VAC	3-14VDC	2450A ² s	AC random output	

Other models available please visit our website www.celduc-relais.com

Three-phase Solid State Relays & Contactors

NEW INNOVATIVE PRODUCTS !

cel3pac

sightpac



SUPERIOR DESIGN, EASY INSTALLATION,
OPTIMUM LIFESPAN AND COMPETITIVE PRICING ARE DELIVERED
WITH OUR NEW GENERATION OF THREE-PHASE SOLID STATE RELAYS

20

21

MADE
IN FRANCE

cel3pac sightpac

New ranges of three-phase Solid State Relays & Contactors

For safety, use our SMB8670910: a SIL3 compliant product with status or diagnostic capabilities.

Performance & reliability

- Maximum peak voltage up to 1600V,
- Thyristor rating up to 125A,
- AC or DC Input control available,

- Using TMS² technology thyristors and RVF process (RoHs Void Free Process) for a longer lifespan (+40%),

- IP20 protection on terminals with removable flaps,
- Overvoltage options: RC snubber, VDR, TVS.

Reference	Thyristor rating	Switching current AC-51 (at 40°C)	Switching current AC-53 (at 40°C)	Switching voltage	Peak voltage	Control voltage	I ² t	Overvoltage options
cel3pac range								
SGT7690500	3x125A	3x64A	3x32A	24-520VAC	1600V	4-30VDC	22 000A ² s	RC - VDR
SGT8678500	3x75A	3x54A	3x16A	24-520VAC	1600V	24-255VAC/DC	7 200A ² s	RC - VDR
SGT8690500	3x125A	3x64A	3x32A	24-520VAC	1600V	4-30VDC	22 000A ² s	RC - VDR
SGT8858200	3x50A	3x42A	3x12A	24-640VAC	1600V	24-255VAC/DC	2 800A ² s	VDR
SGT8859200	3x50A	3x42A	3x12A	24-640VAC	1600V	90-280VAC/DC	2 800A ² s	VDR
SGT8879200	3x75A	3x54A	3x16A	24-640VAC	1600V	90-280VAC/DC	7 200A ² s	VDR
sightpac range								
SMB8670910	2x75A	3x35A	3x16A	150-520VAC	1600V	4-30VDC	7 200A ² s	RC - VDR + auxiliary contact
SMT8620520	3x25A	3x20A	3x5A	24-520VAC	1200V	4-30VDC	380A ² s	RC - VDR
SMT8628520	3x25A	3x20A	3x5A	24-520VAC	1200V	24-255VAC/DC	380A ² s	RC - VDR

Other models available please visit our website www.celduc-relais.com

SSRs GIVE YOU THE FOLLOWING ADVANTAGES COMPARED TO EMRs

- Very high number of switching cycles > 10 millions
- Very low power consumption for control
- Not sensitive to shocks and vibrations
- Very high frequency switching (in temperature control, low switching frequency limits the accuracy)
- Provides special controls and diagnostics

22

23

CONCLUSION

- SSR can be used to control loads (temperature, motors, accessories) for reducing maintenance periods, reducing energy consumption.
- Additional SSR features, such as diagnostics, bus communication and local temperature controller, can save space, wiring effort and provide system information.
- Special attention should be taken regarding circuit isolation limits of SSRs : please consult **celduc® relais** for additional information.

WHY CHOOSE **celduc**[®]'s SOLID STATE RELAYS ?



- TMS² technology in AC
- A very high life expectancy compared to the majority of products on the market
- High quality level
- Special customer products :
celduc[®] **relais** is a specialist in adapting designs to specific customers' applications
- High voltage in DC
- High insulation voltage
- A worldwide presence

For many years, **celduc**[®] **relais** hasn't stopped evolving while the team has remained the same. A dedicated team close to its customers and partners, ready to take on any challenge, in the midst of a severe global competition.

At **celduc**[®] **relais**, we have succeeded in achieving and maintaining efficiency while maintaining a high quality level of production in France.

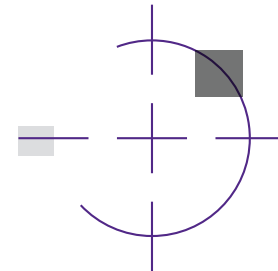

OTHER **celduc**[®] **relais** PRODUCTS

Magnetic Proximity Sensors

We offer a range of products that detect level & flow position, presence or speed of various media.



Reed Relays & Switches

Reed contacts activated through the use of a magnetic field are often used in industrial applications. Our products detect a clearance, a position, a level in extreme environments without a mechanical link between moving parts and without maintenance.

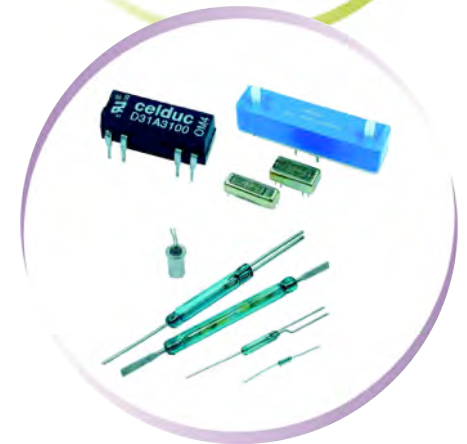

MORE INFORMATION
NEEDED ? www.celduc-relais.com

Catalogues and leaflets available on request



Product Guide



Single Phase SSRs &
Contactors celpac range



Three-Phase SSRs
& Contactors cel3pac
& sightpac ranges



celduc® relais

worldwide presence in more than 60 countries

ALGERIA	MALAYSIA
ARGENTINA	MEXICO
AUSTRALIA	MOROCCO
AUSTRIA	THE NETHERLANDS
BELGIUM	NEW ZEALAND
BRAZIL	NORWAY
BULGARIA	PARAGUAY
CANADA	PHILIPPINES
CHILE	POLAND
CHINA	PORTUGAL
COLOMBIA	ROMANIA
CZECH REP.	RUSSIA
DENMARK	SINGAPORE
EGYPT	SLOVAKIA
ESTONIA	SLOVENIA
FINLAND	SOUTH AFRICA
FRANCE	SOUTH KOREA
GERMANY	SPAIN
GREECE	SWEDEN
HONG KONG	SWITZERLAND
HUNGARY	SYRIA
INDIA	TAIWAN
INDONESIA	THAILAND
IRELANDE	TURKEY
ISRAËL	UNITED KINGDOM
ITALY	UNITED STATES
JAPAN	UKRAINE
LATVIA	VENEZUELA
LITHUANIA	VIETNAM



www.celduc-relais.com

Sales department France : Tél. +33 (0)4 77 53 90 20
Sales department for Asia : Tél. +33 (0)4 77 53 90 19
Sales department for Europe : Tél. +33 (0)4 77 53 90 21
Sales department for America : Tél. +33 (0)4 77 53 90 19

5 rue Ampère - BP 30004 - 42290 Sorbiers - France
Fax : +33 (0)4 77 53 85 51